

REVISION HISTORY	REV/VER	DATE	REVISOR	CHANGE
	A	6/24/09	PEH	UPDATED PRINT STYLE AND CORRECTED DIMS

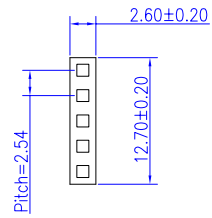

HOUSING

CONNECTOR PINOUT	
PIN NO.	DESIGNATION
1	RT
2	RL
3	SG
4	LT
5	LL

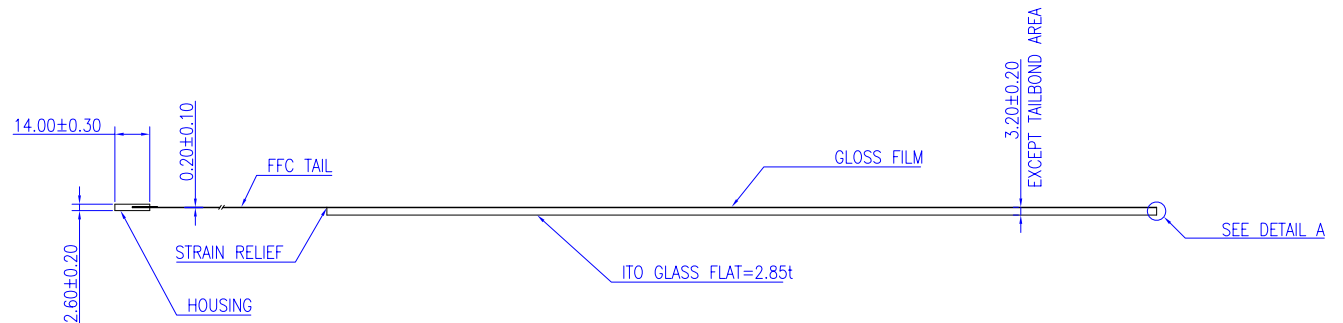
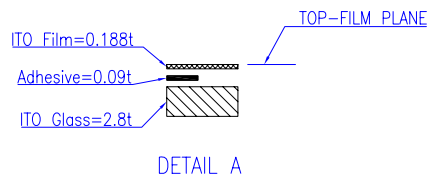
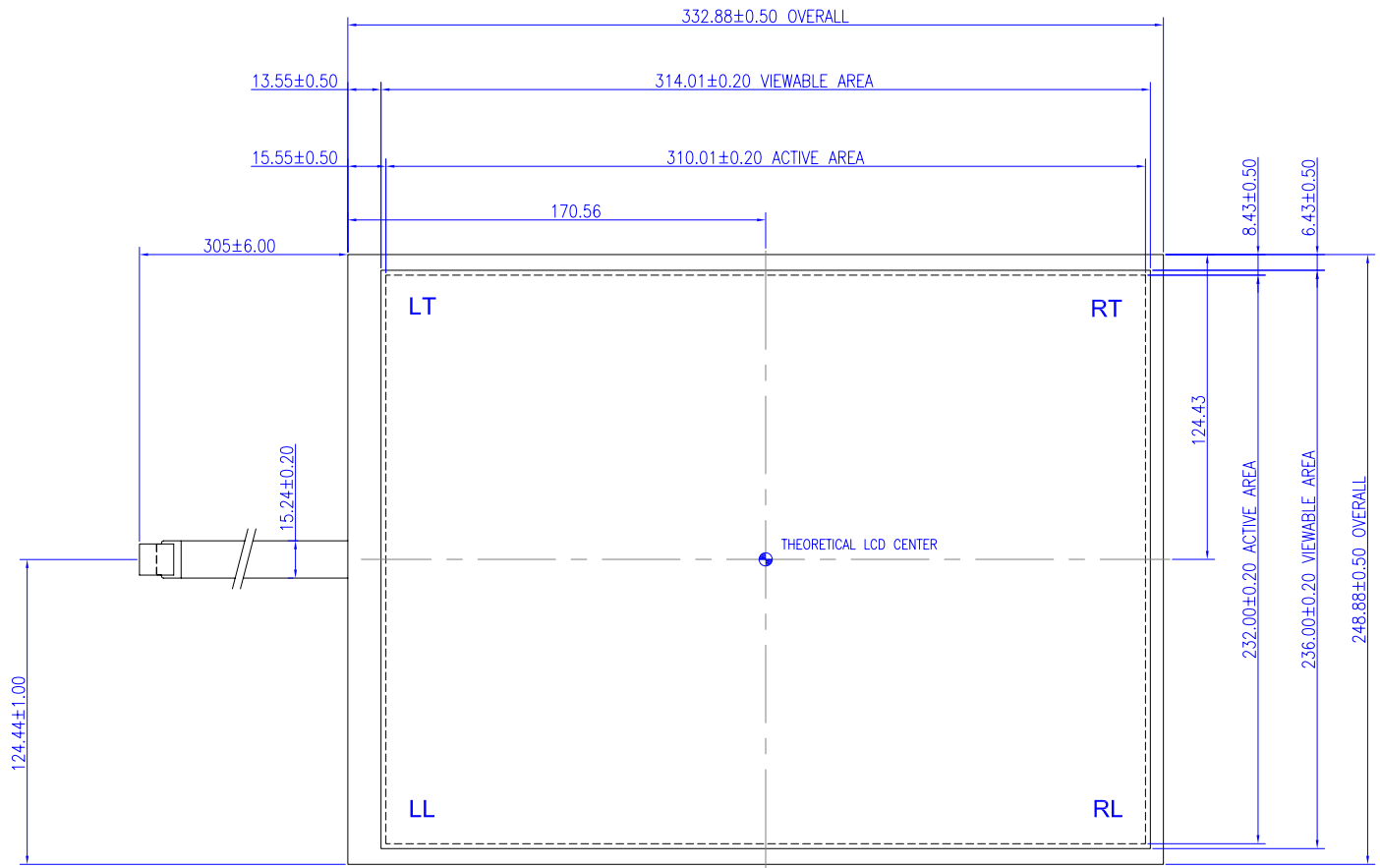
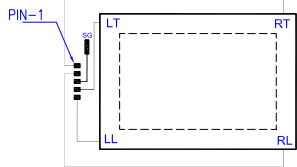

TOLERANCE	AS SPEC'D	DRAWN	PEH	DATE	6/24/09	PART DESCRIPTION	15.1" DIAGONAL 5-WIRE TOUCHSCREEN	
SCALE AS "A"	1/3 X	CHECKED	XXX	DATE	XX/XX/XX			
SHT. SIZE: D	UNITS: mm	APPROVED	XXX	DATE	XX/XX/XX	PART NO.	400407	
							Rev.	Version
							-	A